

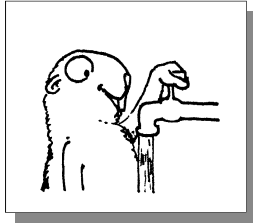

Rue Vanden Corput straat, 51 - Bruxelles 1190 Brussel
Tél: +32.(0)2.672.07.52 - Fax: +32.(0)2.672.61.56
e-mail: sales@ecotechnic.be



Debietmetingen voor gassen en vloeistoffen

Thermische massadebietmeting, variabele oppervlaktes, ultrasone turbines, pitotbuis, orifice, laminair debiet

Debiet- en niveaumeting afvalwater

Analysetoestellen voor (afval)water



Staalnametoestellen voor afvalwater

Vast of draagbaar, programmering met microprocessor

Gekoeld, volledig automatisch

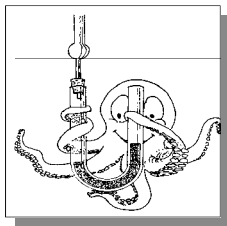

Druk- en drukverschilmetingen

Niveau en druk metingen

Transmitters, uitlezingen (aanduiders)

Grondwater meting

Piezzometer,

GPRS data transmissie



Analyse en detectie van gassen

Staalname, drogen, filtratie

Analyse of detectie van gassen met electrochemische cellen of IR-technologie : CO, CO₂, CH₄, SO₂, O₂, toxische gassen.

Gasstaalnamesondes, drogers volgens het Peltier-effect (methode), koelers

Filters in: PVC, teflon en Inox



Gegevensverzameling

Meteorologische, fysische en chemische parameters

Gegevensverzameling voor 1 tot 384 kanalen, draagbaar of vast, programmeerbaar met PC, bescherming IP 65

Milieuparameters: T°, HR windsnelheid en windrichting, regenval, barometrische druk, watergehalte van de bodem, waterdampgehalte, waterstand en debiet,...

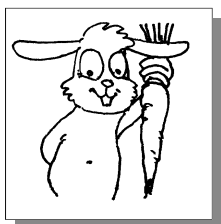

Fysiologie van planten en dieren

Metingen: fotosynthese, bladoppervlaktemeting, wortellengte, waterstress, Fluorescentiemeting van chlorophyl, al of niet gemoduleerd, beeldanalyse.

Meting van dierlijke fysiologie, gedragsstudie

Blank page

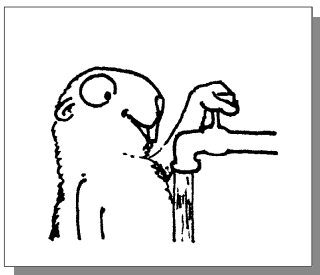

Debietmetingen van gassen en vloeistoffen Debiet- en niveaumetingen (afval)water Water analyse

Zuiver gas en vloeistof

Variabele oppervlakte debietmeters met buis en/of vervangbare vlotter
Lokale aanduiding met pneumatische of elektrische transmitters (zenders) en alarmcontact

Groot gamma : 1/4" tot 6"

Thermische massadebietmeting en -regeling: uitlezing, regeling, gegevens verzameling, afstandsbediening of controle van op afstand

Vloeistofdebietmeting met een peltonturbine

Groot gamma in debieten, werkdrukken en temperaturen, verkrijgbaar in verschillende materialen

Bestaat ook in Atex versie

Afval water meting: Open - gesloten leidingen

Klassieke Flow « Techniek »

Metten van de watersnelheid, waterniveau en het debiet door het gebruik van klassieke techniques zoals Venturi en « V » overflow systemen.

Ultrasonde sondes en druksondes voor gesloten of open kanalen.

Advanced « Techniek »

Cross-correlation en Doppler Ultrasonic techniek voor open of gesloten kanaal

Vaste of draagbare versies gekoppeld aan een datalogger en/of het automatisch nemen van stalen.

Speciale toepassingen en engineering van systemen

Talrijke toepassingen bij de controle van afvalwater, afvoerkanalen of bezinkingsbassins



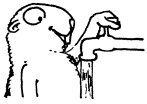

DEBIETMETERS

Vlotter Debietmeters



Orifice Debietmeters



Flow Meters

Highly resistant materials
Suitable for gas and liquid
Bi-stable set point controller



Compacte 'Metal tube' Debietmeters

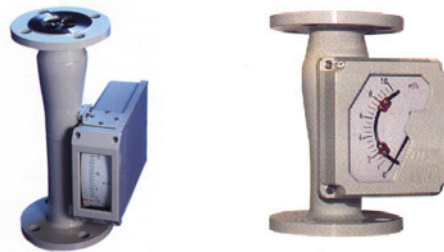

Thermische Massa Debietmeters, Controllers

Electronic manometer



Pitot tube



Plastic modulated

Standaard

Vortex Debietmeters

Hoge performantie - 'Non intrusive' ultrasone sensor



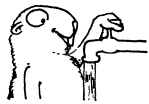

DEBIETMETERS

MAG- Electromagnetische Debietmeters

New Modular System

MAGX2

MagX2



MAGX1
MODBUS



Pelton wheel Flowmeters Turbine

Vortex Debietmeters



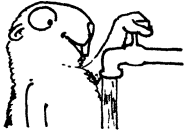

REALISATIES

Enkele voorbeelden

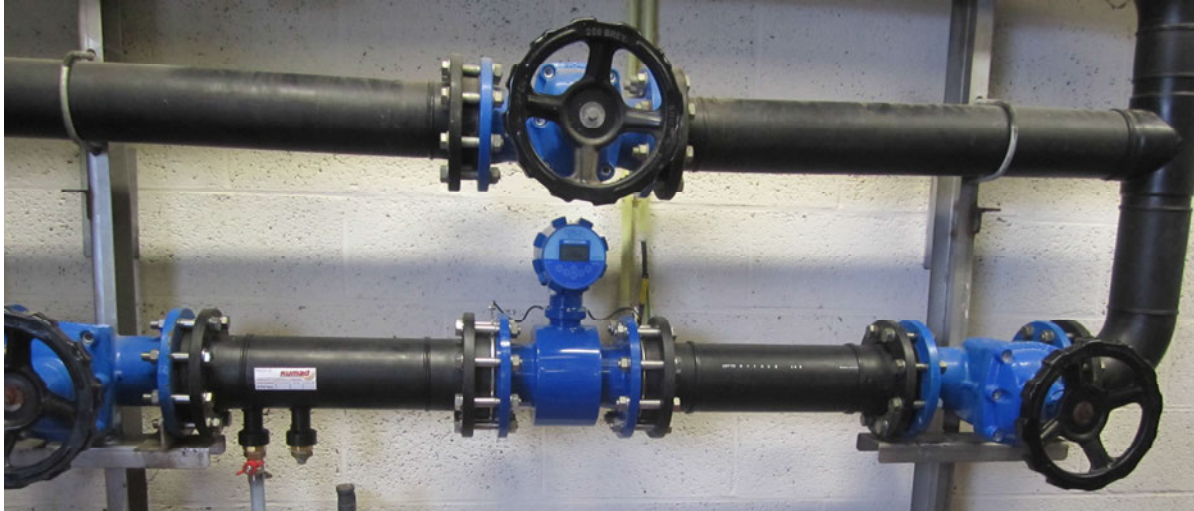

MagX2

On site installation

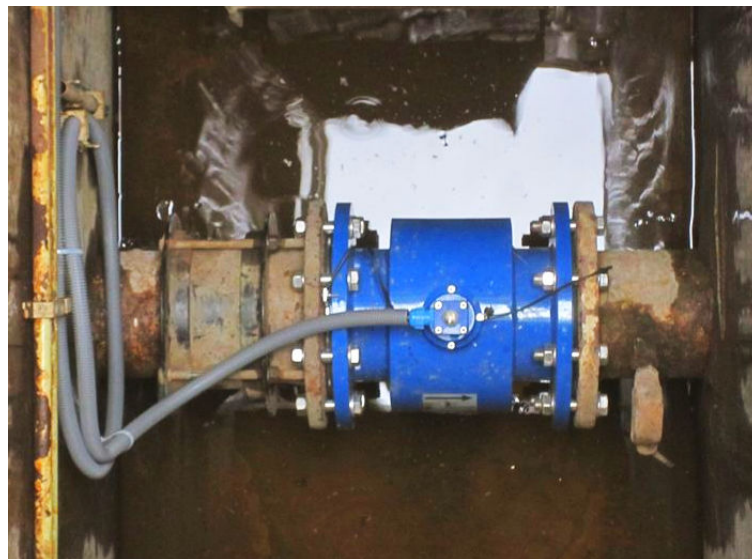

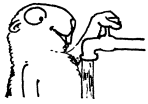

WASTE WATER flow measurements Using Classical technologies

Venturi Flumes and « V » weir

Stainless steel venturi

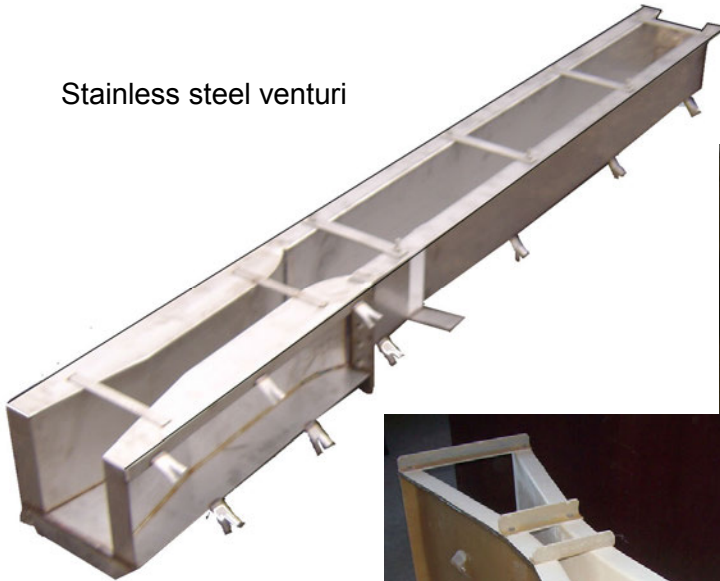

Polyester venturi
Vlakke bodem of Parabolisch



Polyester Parshall

"Bubble meter" Sensor & transmitter



« V » overflow and special measuring systems

Level - Flow - Volume

Ultrasonic sensor



Pulsar Ultrasonic transmitter



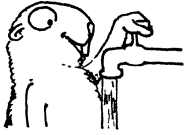

REALISATIES

Enkele voorbeelden

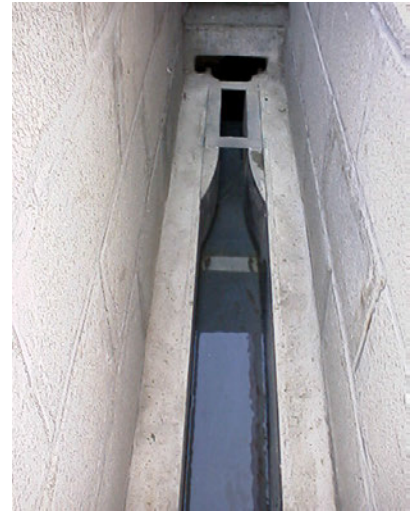

Venturi-flume in polyester
of RVS
Met / zonder
laterale meetkamer



Speciale uitvoering
voor een
verplaatsbare
Parshall meetkanaal



Speciale Venturi-flume
Voor verplaatsbare kanaal

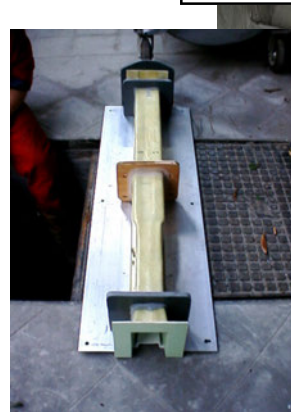

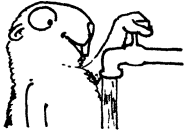

REALISATIES

Enkele voorbeelden



Kleine « V » overloop

Vierkante overloop voor RWZI



Complete syteem:

« V » overloop
pH en temperatuur meting,
Debietmeting

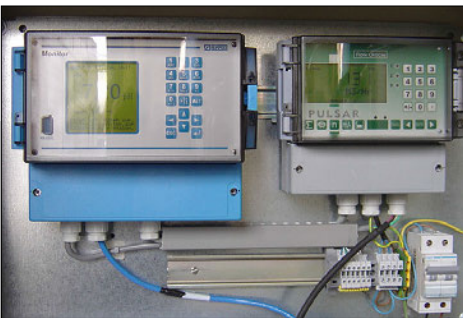

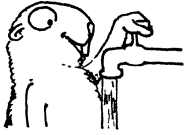

REALISATIES

Compleet meet-station:

RVS venturi kanaal
US (hoogte), debiet
pH en temperature meting
registratie
WEB Serveur



Waste water measurement:
pH - temperature and
flow - totalization

Data treatment and
transmission via WEB Server



Volledig meetsysteem:

Meet en registreert:
Debiet (venturi + ultrason)
pH en temperatuur
Water sampler

Met
data Logging en
ethernet data transmissie



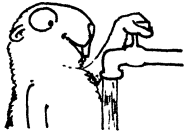

AFVALWATER

Measurements Using Advanced technologies

Draagbaar

Debietmeter met ingebouwde Data Logger

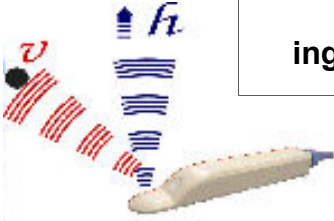

Borrelbuis debietmeter



PCM 4

**ISMA
DLK202**



Vast

Open Kanalen Debietmeting

OCMPro
Cross-correlation US

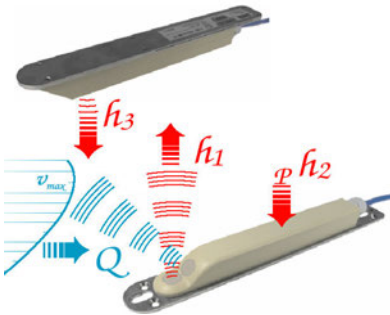

DOPPLER US

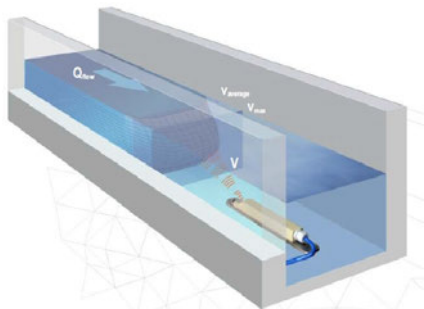

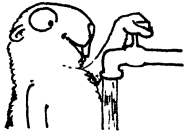

REALISATIES

Voorbeelden

Open Channel Flow Measurement
OCM Pro

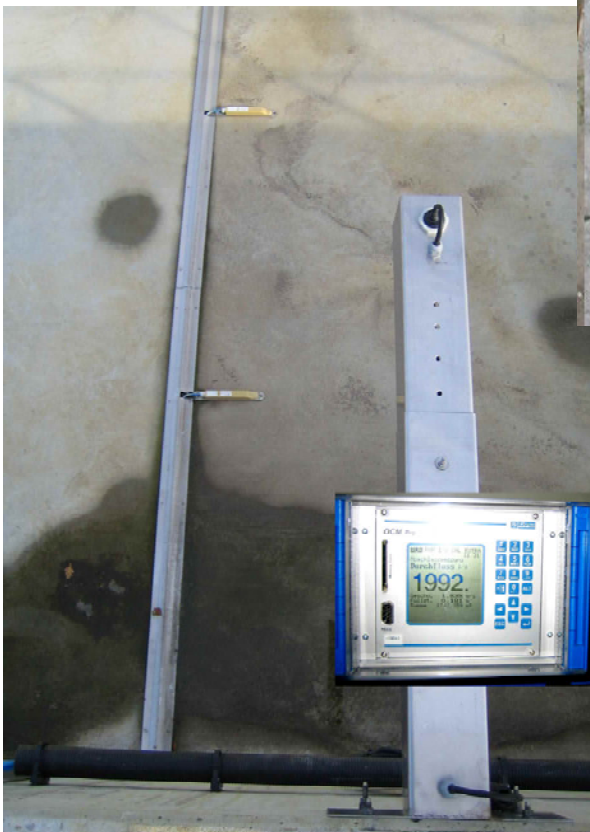

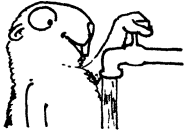

STUDIE EN ONTWERP ENGINEERING

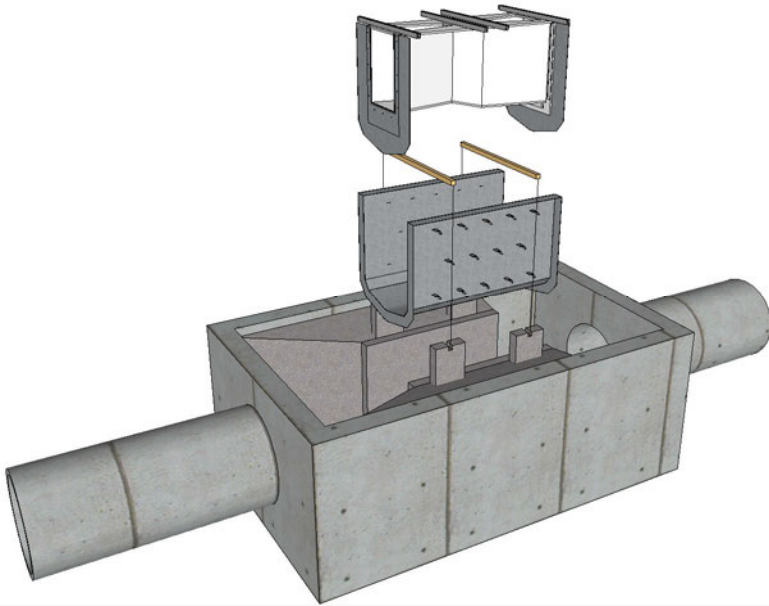

Exploded-view-tekening
Van een verplaatsbare
Parshall meetkanaal

Aanpassing van bestaande mangaten
voor debietmeting voor "V"-schot.
Maatwerk

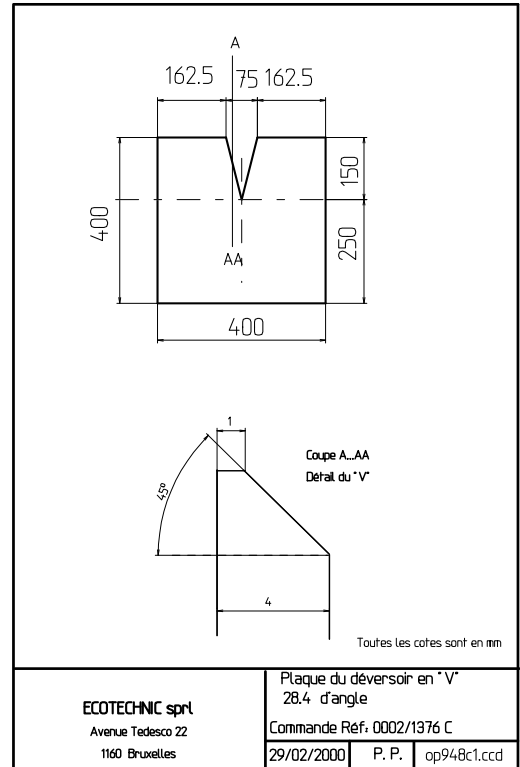

Ontwerp van een venturi-kanaal
aangepast voor plaatsing.

Ontwerp voor een "V"-schot.
Maatwerk

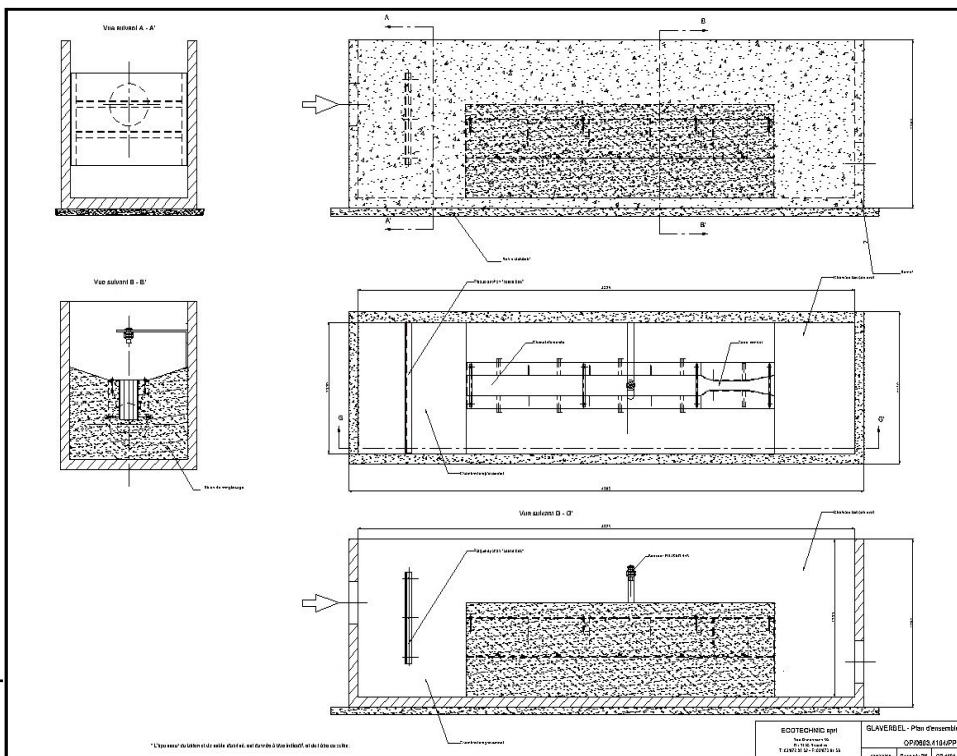

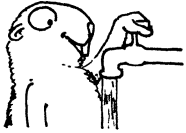

STUDIE EN ONTWERP ENGINEERING

Building en Engineering

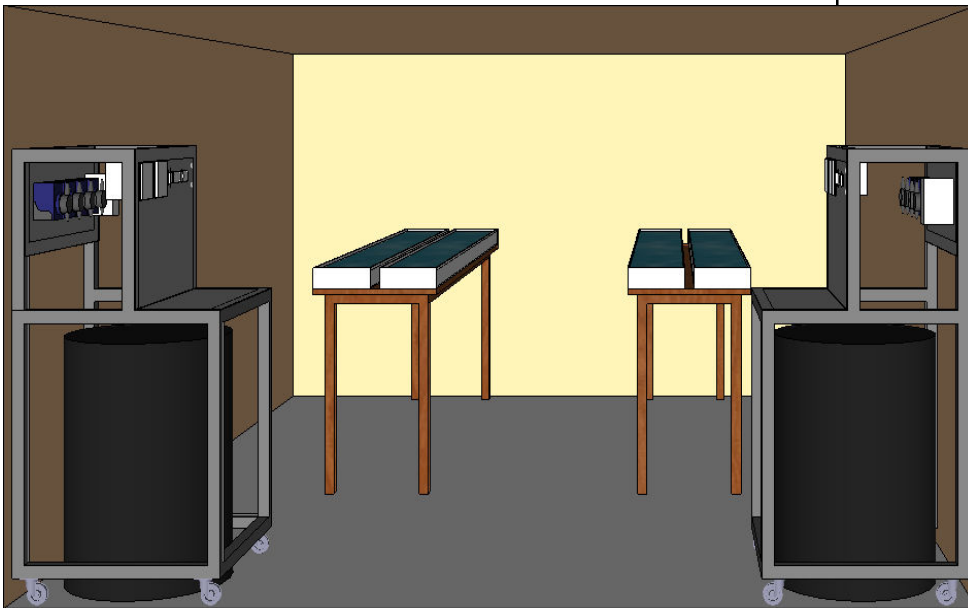

3D aanzicht
Hydropische
Plantgrootkamer.
Kontrole van de
physico-chemische
parameters

Vue 3D aanzicht
Voor de dimensionering
Van een debiet en pH
meetkast

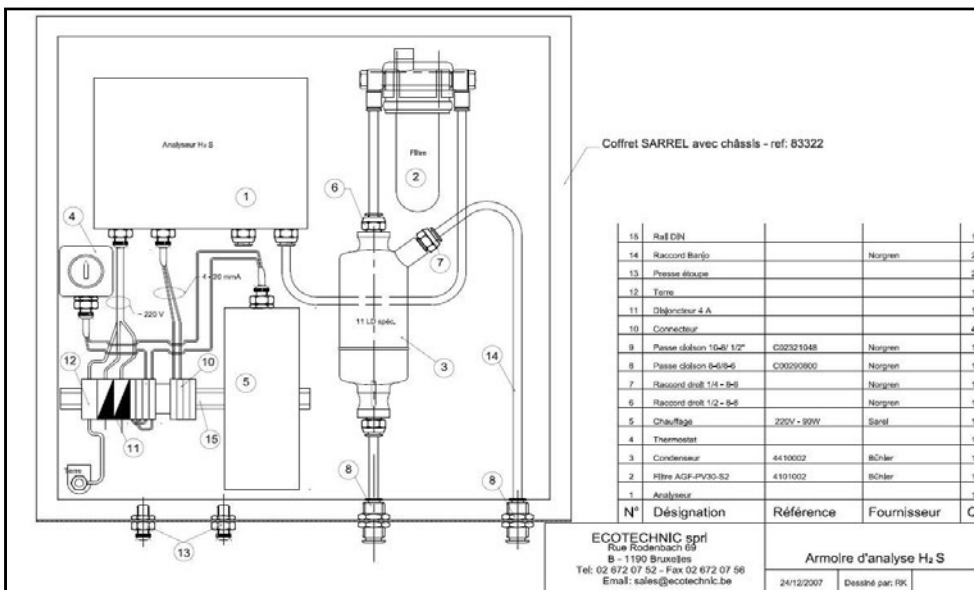
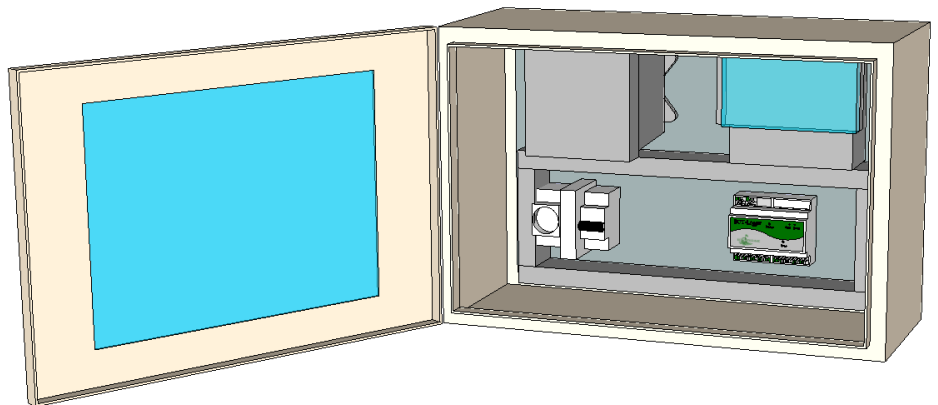

Plan:
Kast met gas
conditionering en
analyse





STAALNAMETOESTEL VOOR AFVALWATER STAALNAMETOESTEL VOOR PRODUCTIEPROCESSEN

WATER ANALYSE

Draagbaar of vast staalnametoestel

Gebruiksvriendelijke programmering met microprocessor dankzij keuzemenu's.
LCD-scherm met 4 x 20 karakters en retro-verlichting.
Ingangen beschermd tegen overspanning.
Ingebouwd uurwerk met batterijvoeding.
RS232 en RS485 interfaces.

Dosering met vacuumpomp of peristaltische pomp.
Gepatenteerd ventielsysteem.
Meerdere modellen beschikbaar voor diverse verdelers / flesjes.
Isothermische behuizing met kompressorkoeling mogelijk.

Water analyse

In situ of draagbaar toestel voor het meten en registreren
van opgeloste zuurstof, geleibaarheid, pH, turbiditeit,...

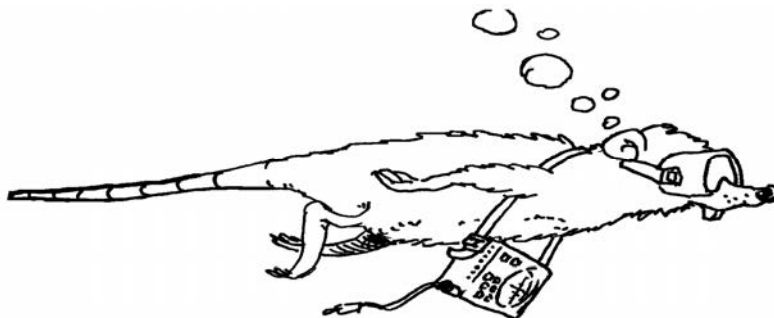



STAALNAME TOESTELLEN

Draagbare Samplers



TP 4C en 4P
Microprocessor gestuurd
Koeling systeem in optie



VIGILANT

In Situ Vaste Samplers



Variaties in staalnameflessen - Mobile versie optioneel - Intern verlicht



'Self-emptying'

Automatische lediging, reiniging en vulling van de flessen.
Motorgestuurd distributiesysteem met beveiliging op slechte werking
Volledige koeling optioneel
Analyse-apparatuur optioneel geïntegreerd

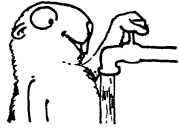

pH - Redox - Conductiviteit - Turbiditeit Opgeloste zuurstof - Chloor - etc...

Electrodes



Aanduiders - Meters - Programmers Data loggers - Web server



Draagbare Toestellen



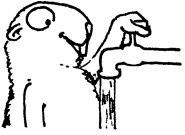

REALISATIES

Voorbeeld

Meting van:
Debiet door een « V » overloop
pH
Temperatuur,

Met data acquisitie

En ethernet data transmissie door optische fiber





Inspecties van collectoren, piezzometers, Volle of lege leidingen

Inspectie van saneringsnetwerken,
afvoerpijpen, buisen, boorwerken, ...
door draadgestuurde karretje



Videinspectiekarretje



Videinspectiekarretje met
verlichting



De controlemiddelen kunnen aangepast worden aan de meerderheid van de gesteldheden, inspectie van afvoerpijpen, rioleeringen of ondergedompelde leidingen.

- Digitale fotos
- Filmcamera op karretje
- TV S.M. Filmcamera
- ROV

Controle van ondergrondse netwerken en uitlekkanalen





Debietmeting in collectoren, Meetcampagne en study

Meet en registratie van debieten
Van collectoren en rivieren

Tijdelijke installatie met registratie



Installatie "op site"
Van een water verhoging
die een juiste meting
toelaat



Debietmeting door Doppler of ultrasonen
technieken
Sonde in de leiding
Registratie toestel bereikbaar
van een bezoeksput

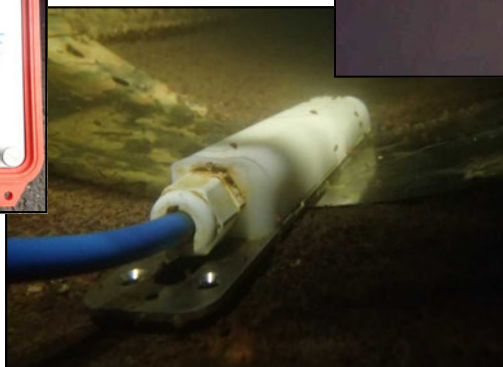

Compleet verslag
Na de meetcampagnes
Xls sheet, pdf, , ...





Interventie in waterzuiveringsstations en collectoren

Waterzuiveringsstation interventie



*De duikploegen zijn uitgerust voor het vervullen
van opdrachten in stuitende omgevingen*

Inspecties - Reinigingen - Controles - Verslagen





Metingen - Services Technische bijstand

Metigen en water monstername op site



Slibniveau en waterdiepte
metingen



Zichtbaarheid meting op het
terrein



Technische en Veiligheid
Bijstand "op het water" tijdens
de opnames van een film

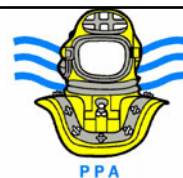

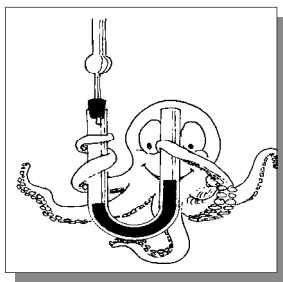

DRUK- EN NIVEAUMETING

On-line druk sensoren en transmitters; onderwater werkende sensoren

Ultrasonische sensoren en level switch voor niveau, en pomp controle,

Hoek transitter

Analoge en digitale manometers met schakelbare gamma's

GRONDWATER METING

Piezzometer, druk sensoren,

Multiparameter sondes,

Mogelijkheid van GPRS data transmissie

Netwerk software

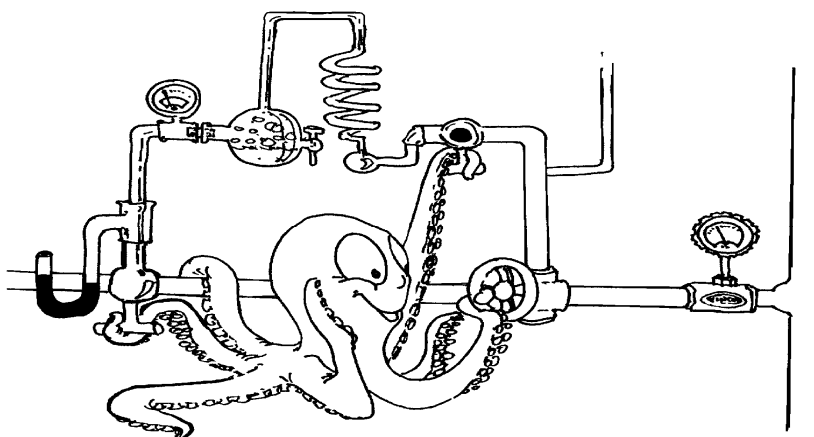

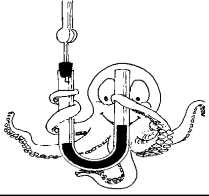

PRESSURE AND LEVEL INSTRUMENTS

Level measurement and control



Ultrason niveau detectie



Float level detector



Ultrasonic Level measurement



Pressure sensor

Inclinometer
Angle transmitter
NDW

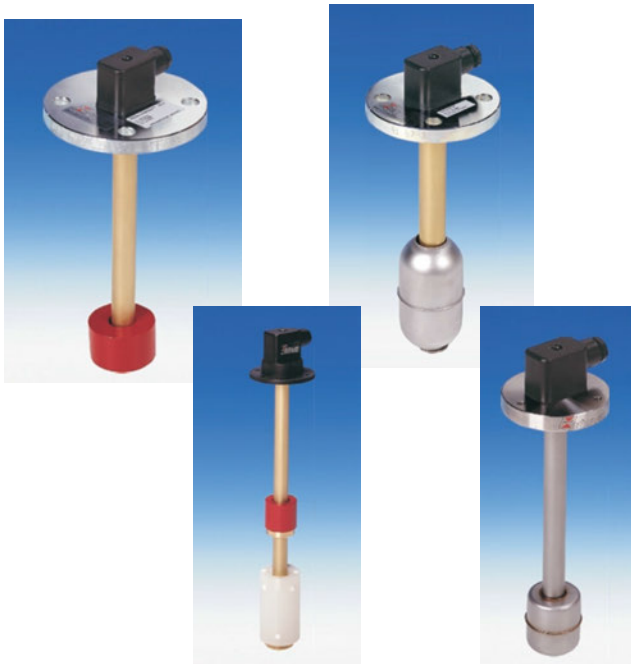

Meet en detectie van Niveau en Temperatuur
« Tank Top Level Control »

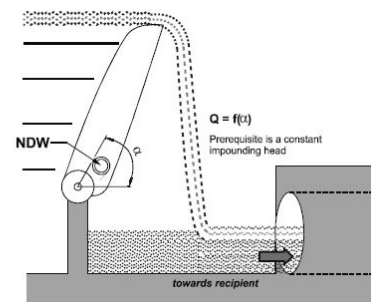



ANALYSE EN DETECTIE VAN GASSEN STAALNAME, DROGEN EN FILTREREN

Gasconditioneringssystemen met keramische filters, verwarmd, te gebruiken in schoorstenen, gasleidingen, ...
Staalname temperatuur tot 1800°C

Gasdrogen met semi-permeabel membraan
Koeler zonder freon, TUV-gekeurd, in normale of Atex-uitvoering of volgens Peltier-effect.
condensaatafscheider met automatische purge

Staalnamepompen, zonder membraan maar met vouwbalg, volledig in Teflon voor corrosieve gassen, met of zonder condensaat, Atex



Analysefilters volledig in Inox , PPH , PVDF ,
PFTE
Maximale druk 315 bar
Maximale temperatuur 180 °C
Filtratie van 2 tot 100 µm , vervangbare
elementen

Analyse of detectie van gassen met IR-technologie of electrochemische cellen
Meten van atmosferische pollutie: CO, CO₂, SO₂, CH₄, NO, NO_x, HCl, O₂, NH₃,
Freon,

Toepassingen bij de controle van uitstoot van verbrandingsovens, regeling van
verbrandingsprocessen, biogassen op stortplaatsen, serres, brouwerijen,

Detectie van explosieve en toxische gassen: NH₃, Cl₂, O₃, HCN, HF, H₂S, H₂, NO, Br₂,
ClO₂,

Studie , ontwerp en realisatie van analysesytemen

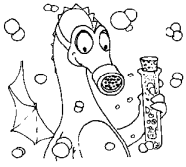

GASDETECTIE EN KLEINE ANALYSERS

Toxische Gassen Transmitter en portable detector

Analyser to measure CO, CO₂, CH₄...
IR or EC cells



Gas Detectoren:
individuele bescherming



Zuurstof detector en
analyser



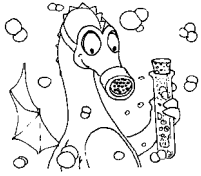

CONDITIONERING

Om een nauwkeurige en betrouwbare meting te verkrijgen met een online analyser is het veelal noodzakelijk dat het gasstaal voor de meting geconditioneerd wordt.



Sample probes

Basisconcept maar aanpasbaar volgens applicatie
al dan niet verwarmd
in/out filter
'Blow-back' controller



Sample pumps

Onaangetast door condensaat houdende gassen
Hoge corrosiebestendigheid
Atex motor standaard



Sample Filters

Uitgebreid gamma van fijn tot coaliserend
Bypass en drain connecties facultatief

Sample Coolers

Enkelvoudige of meervoudige gasstromen
Verschillende soorten warmtewisselaars
Self-controlling met alarm-outputs
Atex-versie verkrijgbaar



Sample Gas Conditioning System 19" Rack

includes all necessary gas conditioning components

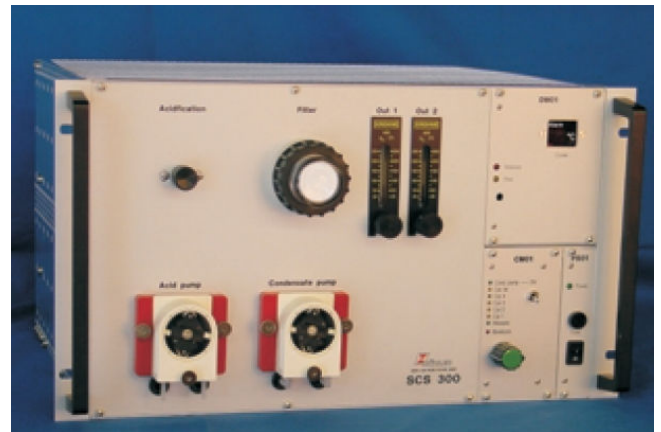

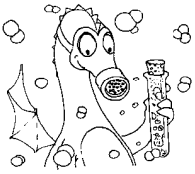

GAS ANALYSERS

Multi-gas analyser

Up to three gases simultaneously
IR - ECC or paramagnetic
measuring technics

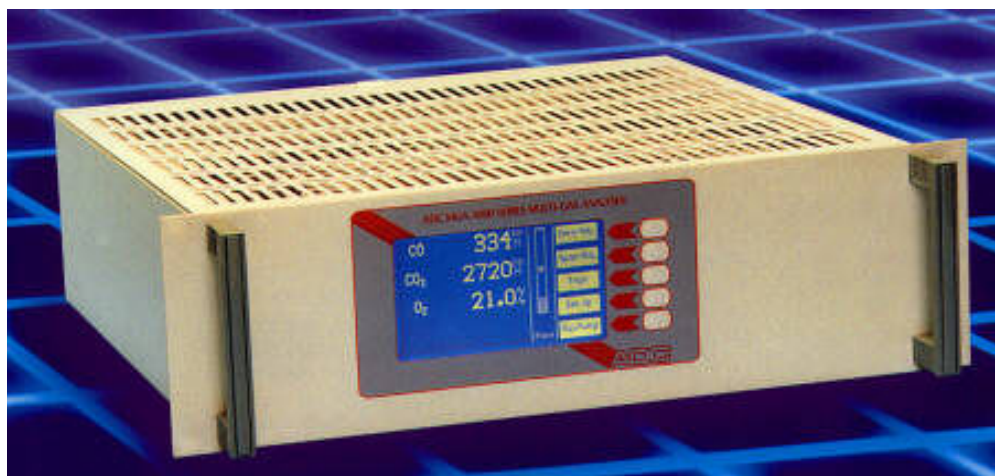

NOX → NO Converter

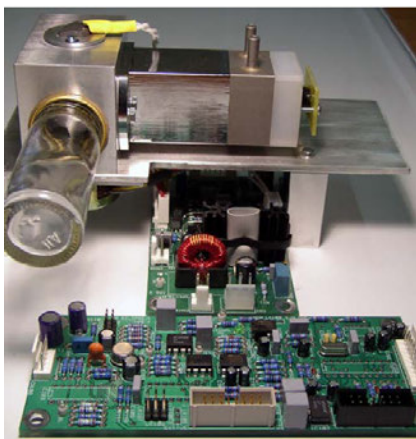

OEM

Infrared Optical Bench
Up to 3 gases
simultaneously

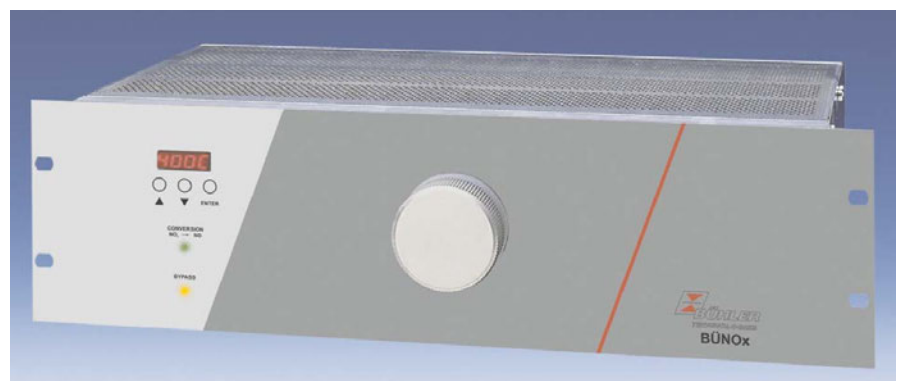

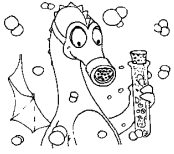

GAS ANALYSIS SYSTEMS

Enkele voorbeelden



Ambiant H₂S analysis
Based on Small IRM750 analyser
Small cabinet with gas sampling



Ambiant CH₄ analysis
Based on MGA3000 analyser
CH₄ analysis
Indoor or Outdoor Cabinet
with gas sampling



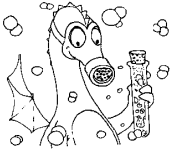

GAS ANALYSIS SYSTEMS

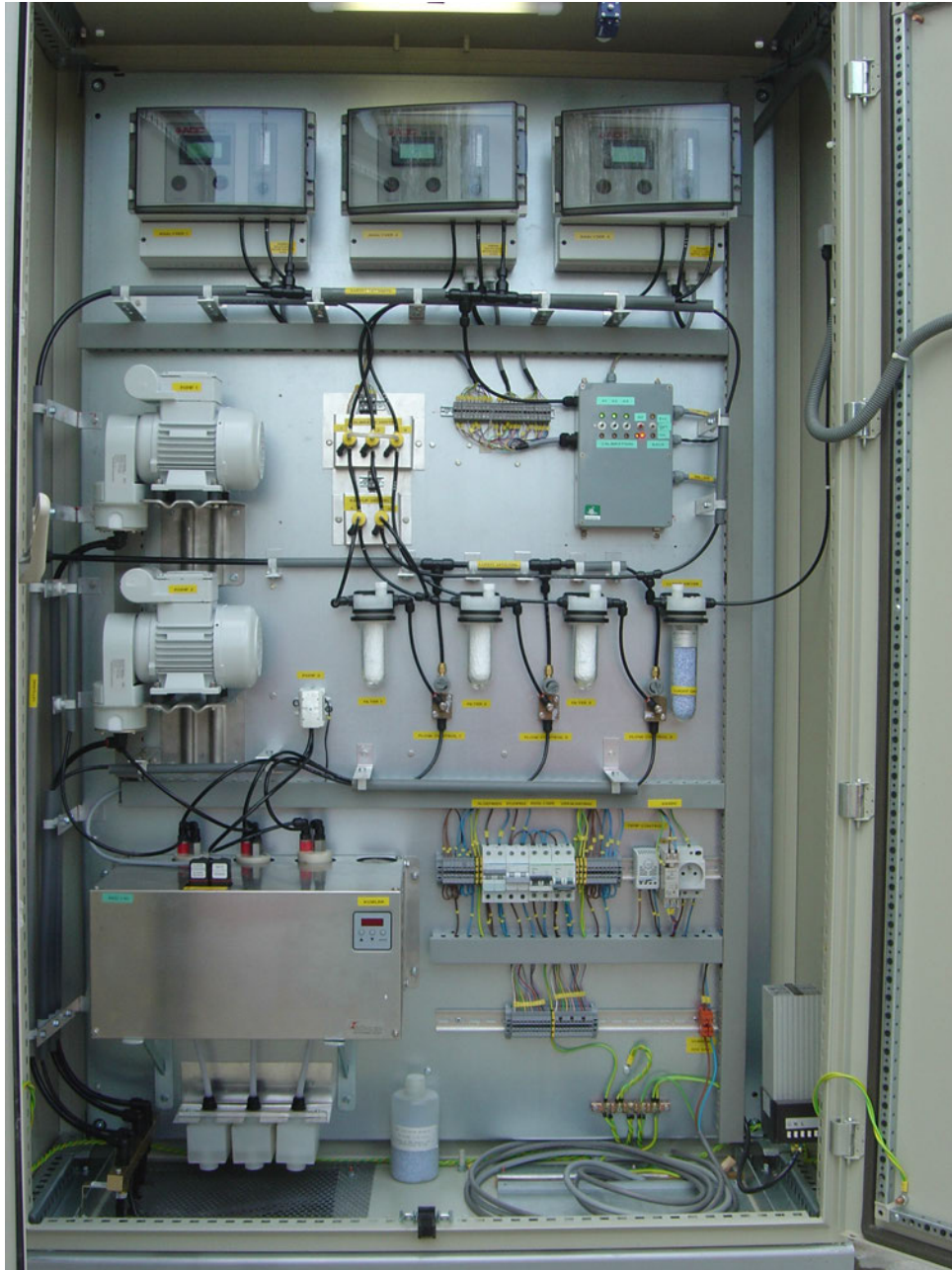

CH₄ en H₂S gas analyse
Met gas voorbereiding

In een WKK installatie



GEGEVENSVERZAMELING METEOROLOGISCHE, FYSISCHE EN CHEMISCHE PARAMETERS

Gegevensverzamelingsunit voor 1 tot 60 kanalen
Programmeerbare ingangen: TC's, Pt 100, analoog, digitaal
Resolutie aanpasbaar aan de behoeften: 8, 12 en 17 bit
Snelheid en intervallen van de data-acquisitie zijn programmeerbaar met PC of
manueel,
software programmeerbaar zowel in DOS als in WINDOWS

Toepassingen in de meteorologie,
temperatuurbewaking bij ovens en
koelkasten
evenemententeller, opnemen van
gegevens in de afvoerkanalen en
bezinkingsbassins,...

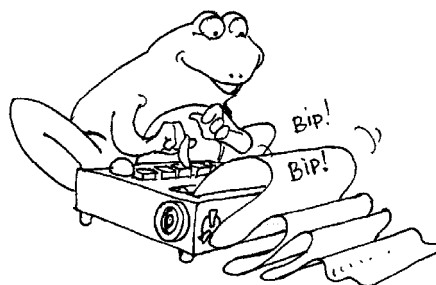

Sondes en meetapparatuur voor fysicochemische parameters:
Lucht- en watertemperatuur, relatieve vochtigheid, atmosferische druk,
windsnelheid en windrichting, regenval, lichtintensiteit over een breed spectrum,
UV,
watergehalte van de bodem, grondwaterpeil, water- of luchtdebiet, pH,
geleidbaarheid, opgeloste O₂

Ontwerpen van meteorologische onderzoekstations, industrieel of huishoudelijk.



GEGEVENSVERZAMELING METEOROLOGISCHE, FYSISCHE EN CHEMISCHE PARAMETERS

Meting van:

- Luchttemperatuur
- Grondtemperatuur
- Relatieve vochtigheid
- Windsnelheid
- Windrichting
- Licht en radiatie intensiteit
- UV-intensiteit
- Atmosferische CO₂
- Atmosferische druk
- Regenval
- Warmteflux
- Grondwaterpeil
- Grondwatergehalte
- Grondzuigspanning
- Waterhoogte
- Water- of luchtdebiet
- Water- of lucht kwaliteit



Gegevensverzameling

- 1 tot 60 kanalen
- Programmeerbare ingangen: Pt100, TC's, analoog, digitaal
- Kanalen individueel programmeerbaar via PC
- IP65 behuizing
- RS232 communicatie,
- Voeding 12V interne externe of zonnepanel

Milieu en Weerstations
Op maat



GEGEVENSVERZAMELING METEOROLOGISCHE, FYSISCHE EN CHEMISCHE PARAMETERS



Verbrandings-
oven

Steengroeves

Composterings-
eenheid



Landbouwonderzoek



Stortplaatsen

MET
Onderzoekslabo

Realisaties: Meteorologische
bewakingsstations voor de site
(verbrandingsovens, stortplaatsen,
chemische bedrijven,...), of atmosferische

Blank page

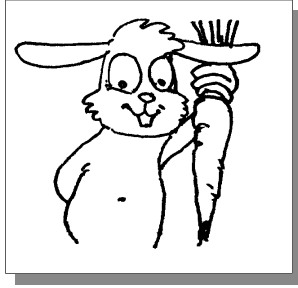

PLANTAARDIGE FYSIOLOGIE

Meet- en registratieapparatuur voor de fotosynthetische parameters: CO₂, H₂O
Draagbare versie en laboversie met de mogelijkheid om de analyseparameters in te stellen:

CO₂ en H₂O gehalte in de lucht, lichtintensiteit, temperatuur.

Metten en registreren van CO₂, temperatuur, HR en PAR

Metten en regelen van CO₂ in serres en *kweekkamers*

Metten en registreren van grondrespiratie

Software voor gegevensoverdracht naar PC

Draagbare drukkamer, meting van waterstress bij planten

Analoge of digitale uitlezing

Drukgamma van 0-40 bar of van 0-70 bar

Fluorescentiemeting van chlorophyl, al of niet gemoduleerd

Laboversie of draagbare versie, gegevensregistratie in het geheugen of op diskette, visualisatie van de grafiek

Analyse-software van de gegevens onder Windows

Beeldanalyse toegepast bij plantaardige fysiologie, zwart/wit of kleur

Software onder DOS en Windows

Toepassing bij het tellen van graan, bladoppervlakmeting, meten van de wortellengte

meten van de gezonde of zieke oppervlakte, meten van necrose, meten van chlorose

Debietmeting van het sap in takken en stammen, diameter van 12 mm tot de volwassen boom

Aansluitbaar op een gegevensregistratietoestel

Meting van dierlijke fysiologie: ademhaling, hartritme, temperatuur.....

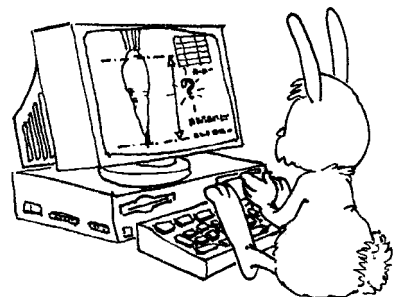

Specifieke catalogus op aanvraag



PLANTAARDIGE FYSIOLOGIE



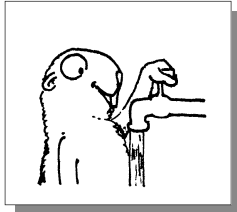

**AQUALYSE
BROOKS
LITRE METER
TOKYO KEISO
PULSAR
HANNA**



**AQUALYSE
MAXX**

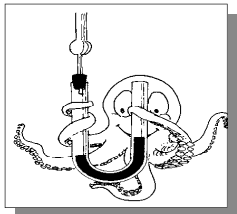

**BÜHLER FLUID CONTROL
PULSAR
UIT
TOKYO KEISO**



**ADC GAS ANALYSIS
BÜHLER TECHNOLOGIES
OLDHAM-EIT
GS MESSTECHNIK**



**DELTA-T
ENVIRONMENTAL MEASUREMENT
IMKO
REBS
SKYE
UP
VECTOR**

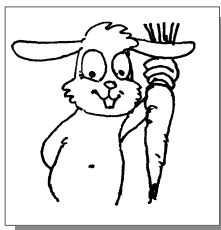

**ADC BIOSCIENTIFIC
DELTA-T
DYNAMAX
HANSATECH
OPTI-SCIENCE**

**PMS
PP SYSTEMS
SKYE
UP
WESCOR**

Blank page